



SeAH TURBO BLOWER

Eco-friendly, High Efficiency Turbo Blower



SeAH 세아산업주식회사

세아산업주식회사

서울시 금천구 가산디지털1로 119, A동 1108호 (가산동)

Tel. 02 854 6666, Fax. 02 854 6004, E-mail. seah@seahcomp.co.kr

www.seahcomp.co.kr

SEAH INDUSTRY CO., LTD.

(GaSan-Dong) A-1108 119, Gasan digital 1-ro, Geumcheon-gu, Seoul, Korea

Tel. 82 2 854 6666, Fax. 82 2 854 6004, E-mail. seah@seahcomp.co.kr

SeAH 세아산업주식회사

**Being a industry leader,
High efficiency turbo blower for green future**

The best turbo technology achieved by long-term, constant research and development realizes turbo blower corresponding to the needs of low-energy green future.



PROVEN TECHNOLOGY IN A LEADING DESIGN

The most cost effective technology for driving down your energy

- Optimally integrated core technologies for air foil bearings, motors, impellers, etc. provide stability and reliability for operation.
- Optimized motor speed control technology using a variable frequency drive(VFD) makes it possible to maximize productivity with minimal energy consumption.

Providing all-in-one packages of what you want

- The turbo blower realizes single unit package integrating all functions such as programmable logic controller(PLC), variable frequency drive(VFD), etc.
- The state-of-the-art design ensures energy and time saving effects without auxiliaries.

Keeping working environment with your peace of mind

- 100% Oil-less system makes turbo blower free from the productivity losses and maintenance expenses due to oil permeation.
- Provides comfortable operation with low package vibration and noise less than 80 dB(A), not requiring additional foundation work.

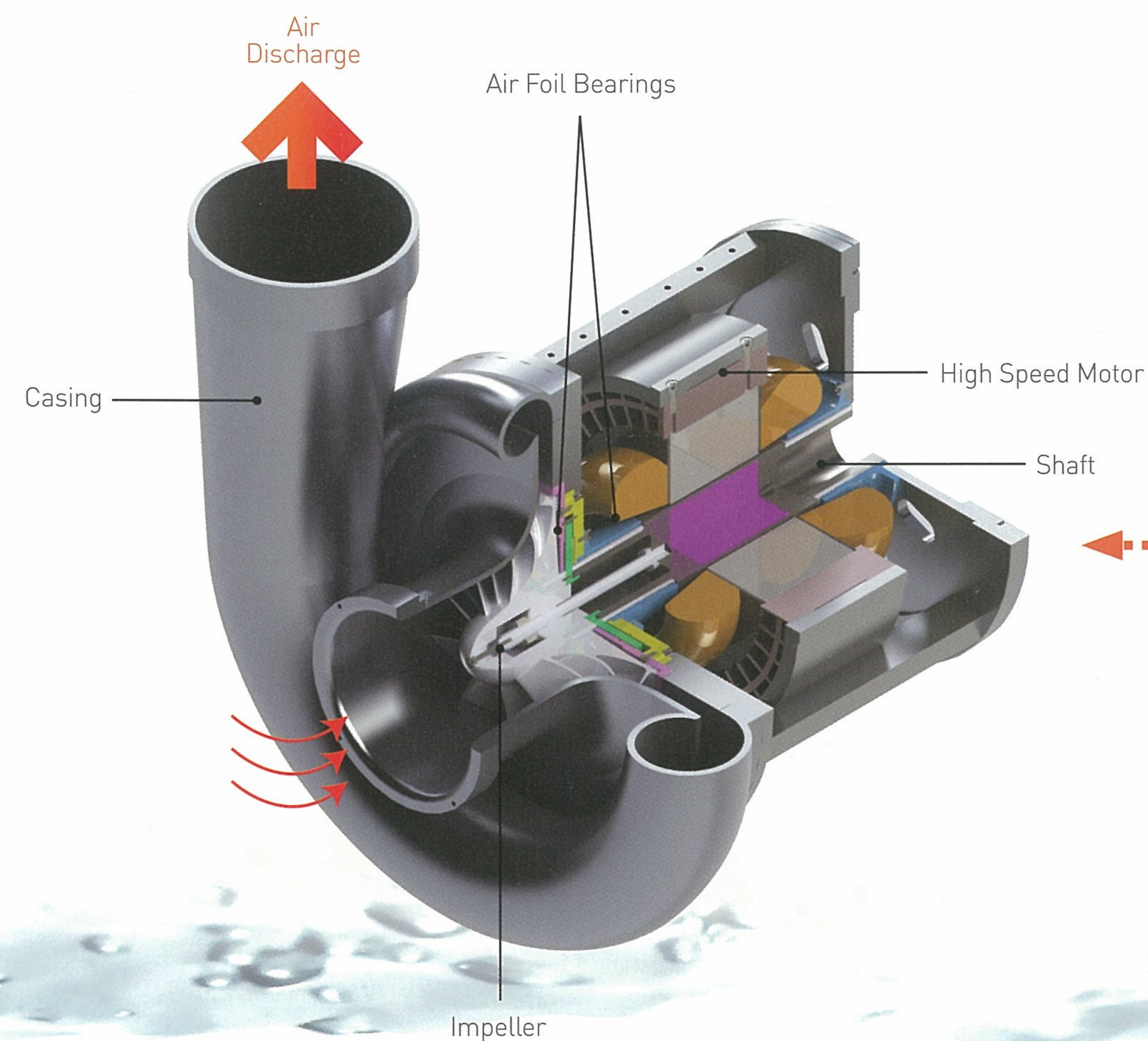

THE FULL FEATURE OF THE TURBO BLOWER



THE PERFECT HARMONY IN EVERY TECHNOLOGY DETAIL

High efficiency and eco-friendly turbo blowers by perfect combination between stability and efficiency.

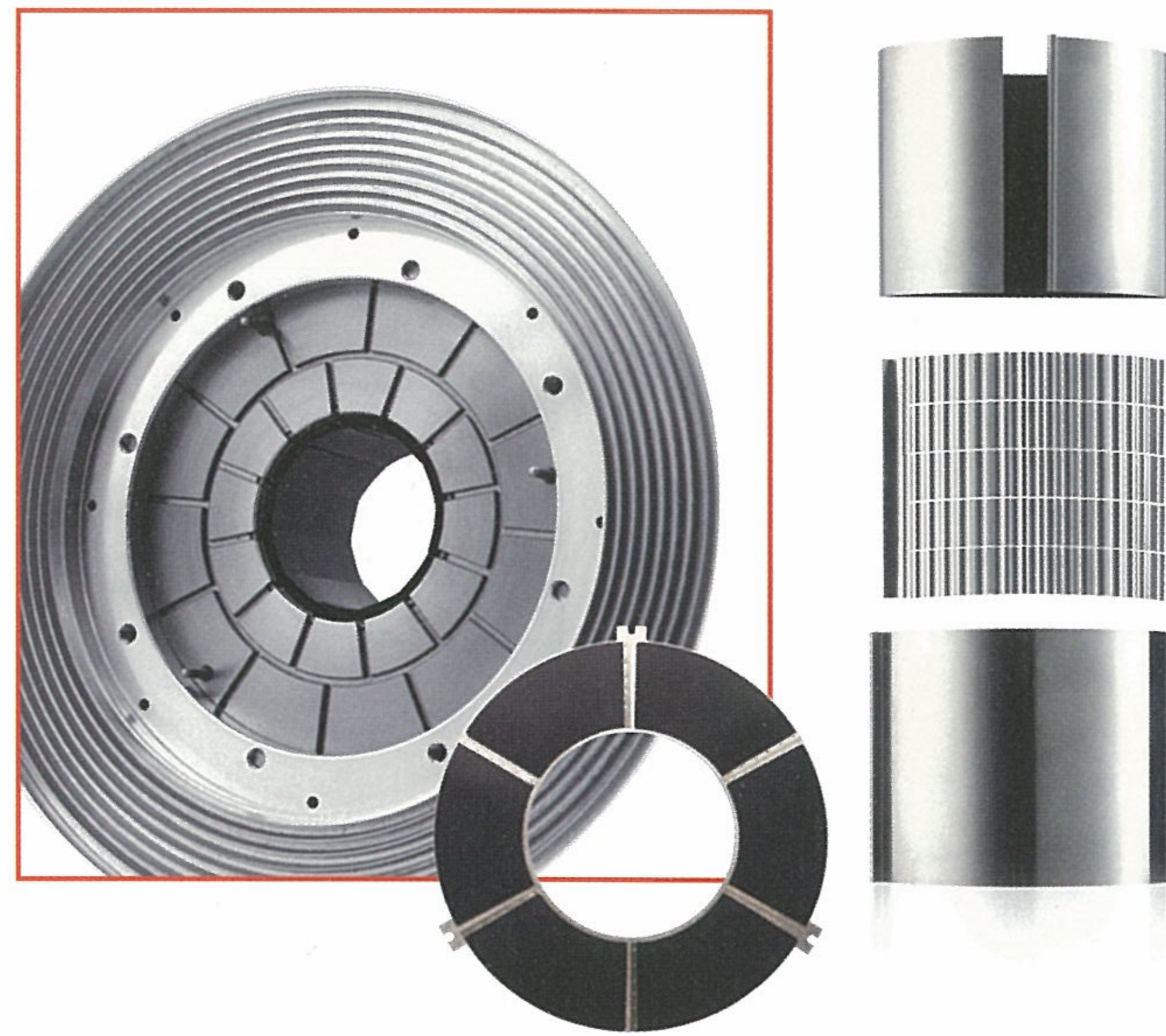

UNIQUE AIR FOIL BEARINGS

- Adoption of hydrodynamic design to use air film between shaft and bearings made by high speed rotors
- Non-contact bearings without friction with shafts during rotation maximizes energy efficiency
- 100% Oil-less & air lubricated system

ADVANCED CONTROL AND MONITORING

- User-friendly interface with graphical display
- Realization of Plug & Play solution enables quick installation with minimum preparation
- Programmable Logic Controller(PLC) provides more versatile and flexible operation against environmental changes
- Built-in various control modes and communications protocol

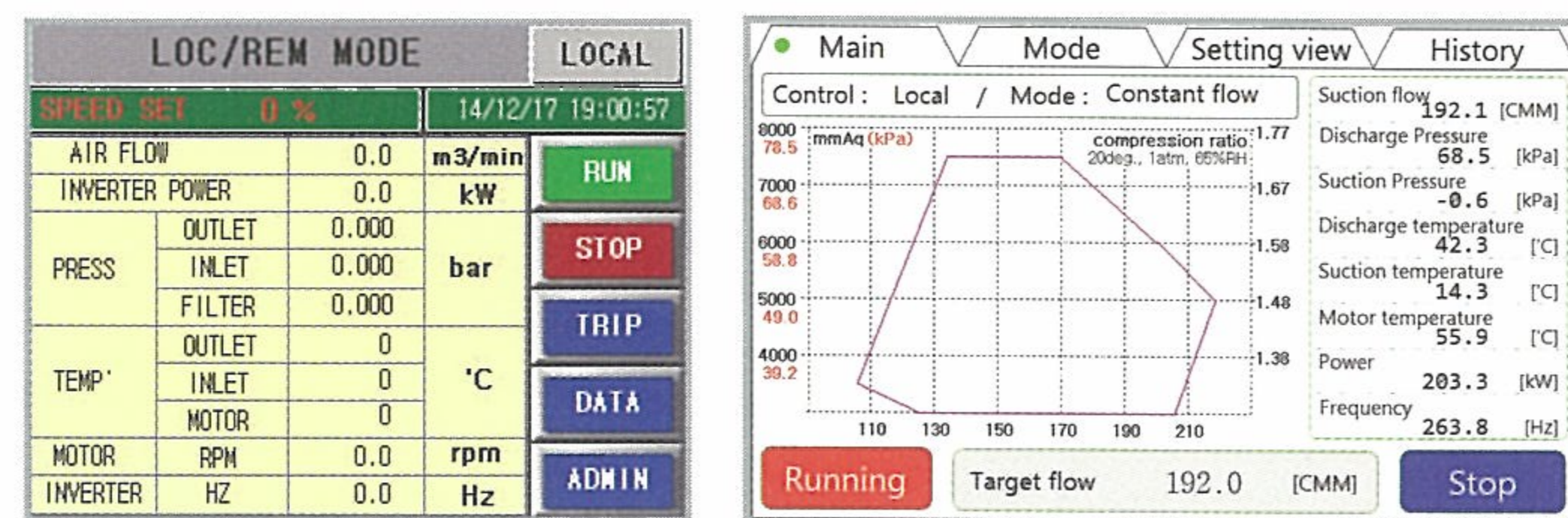

HIGHEST DURABILITY, HIGH SPEED MOTOR

- Patented self-cooling system provides high efficiency over whole working range during high speed rotation (Pat. No. : 10-0481600)
- Featuring a simple design, it also provides excellent durability in extreme conditions
- Supplied with high speed induction or permanent magnet synchronous motors

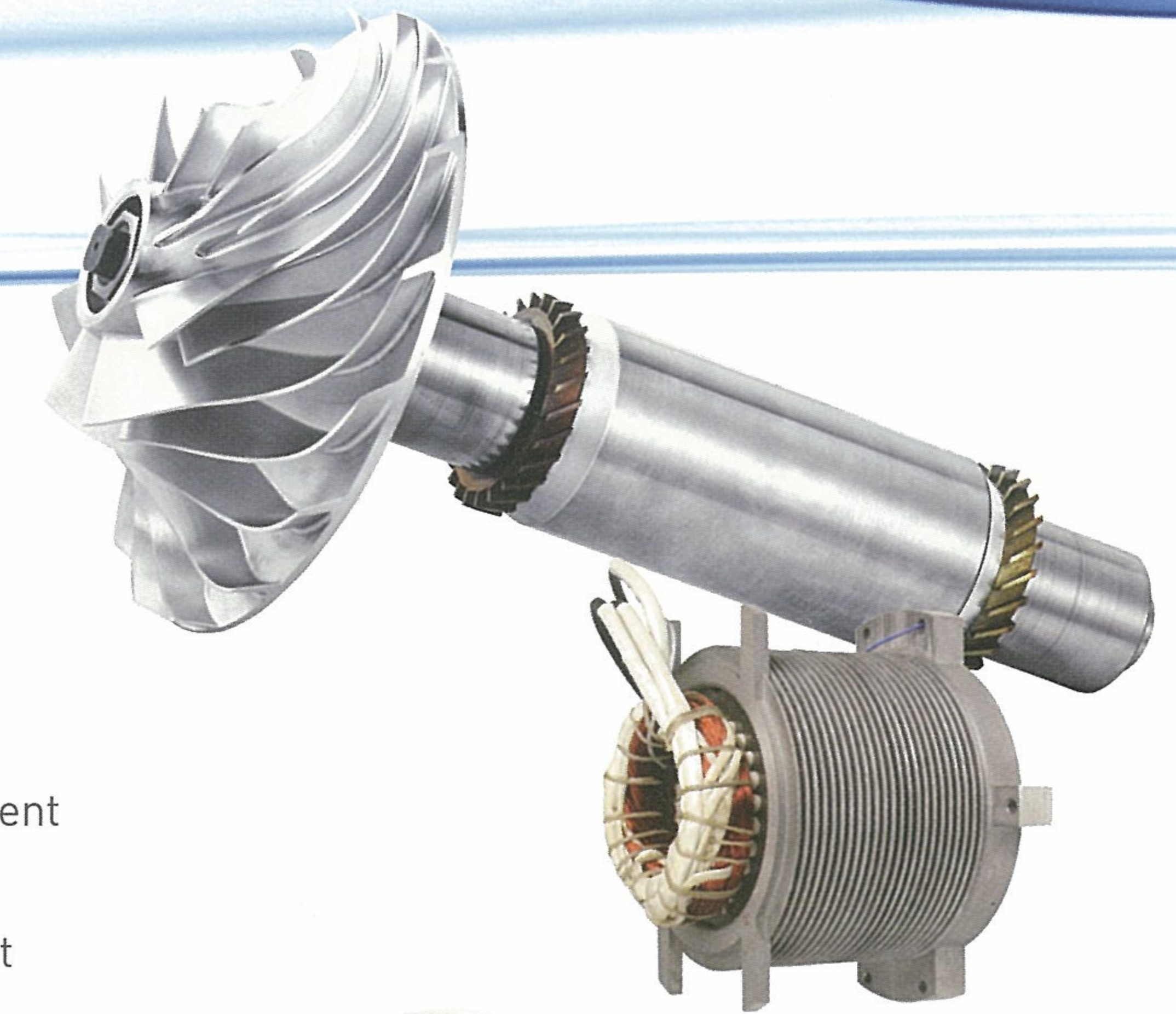

HIGH EFFICIENT MILLED IMPELLER

- Backward leaning type impellers allow for high efficiency
- Optimized assembly technology increases efficiency and turndown range
- 5-Axis CNC machining provides greatly precise design shape and superb durability

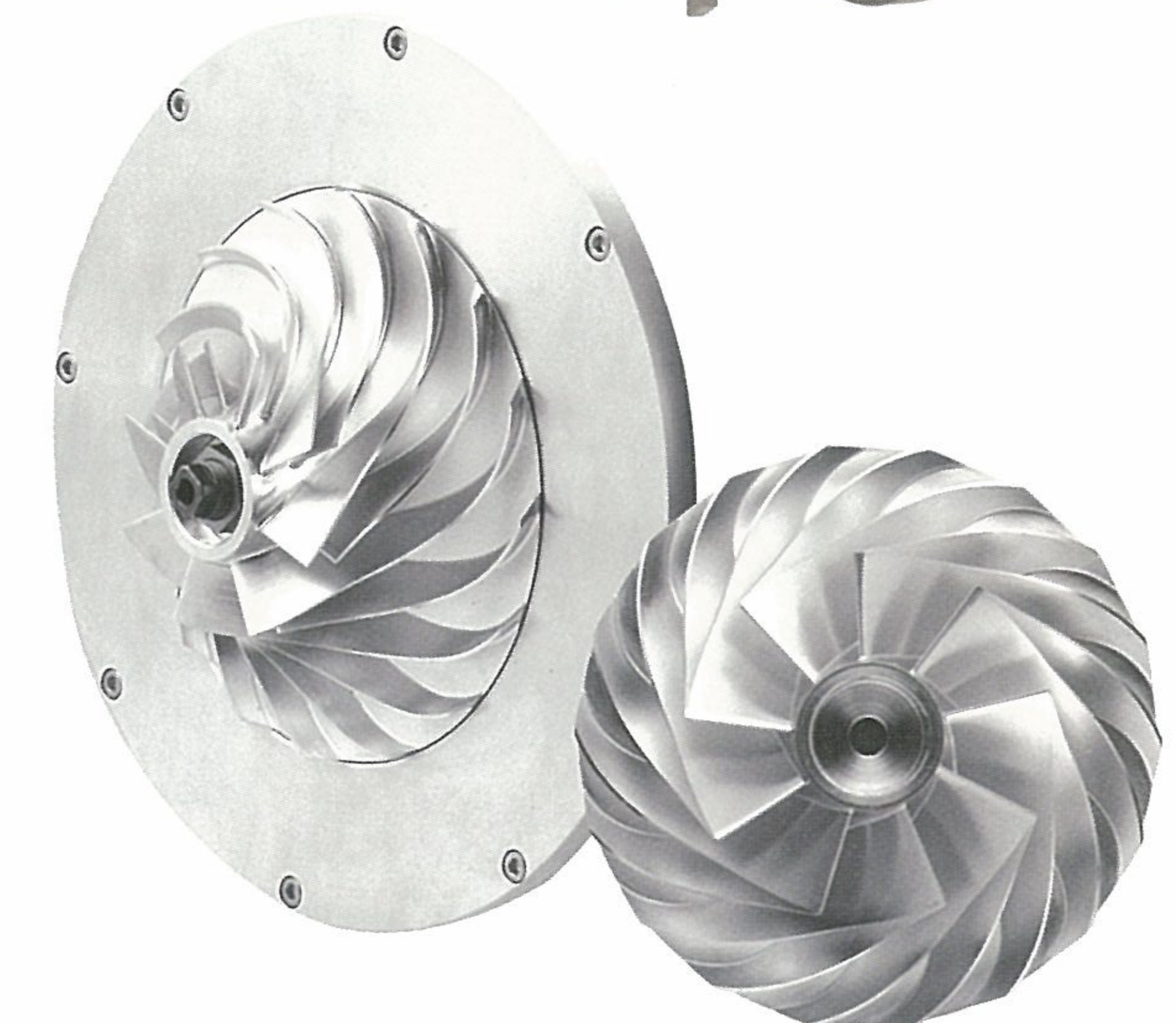

SIMPLE AND POWERFUL COOLING SYSTEM

- Simple and high efficiency cooling system without auxiliaries (air / liquid cooling type)
- Self-cooling system by inlet air for motor and electrical parts

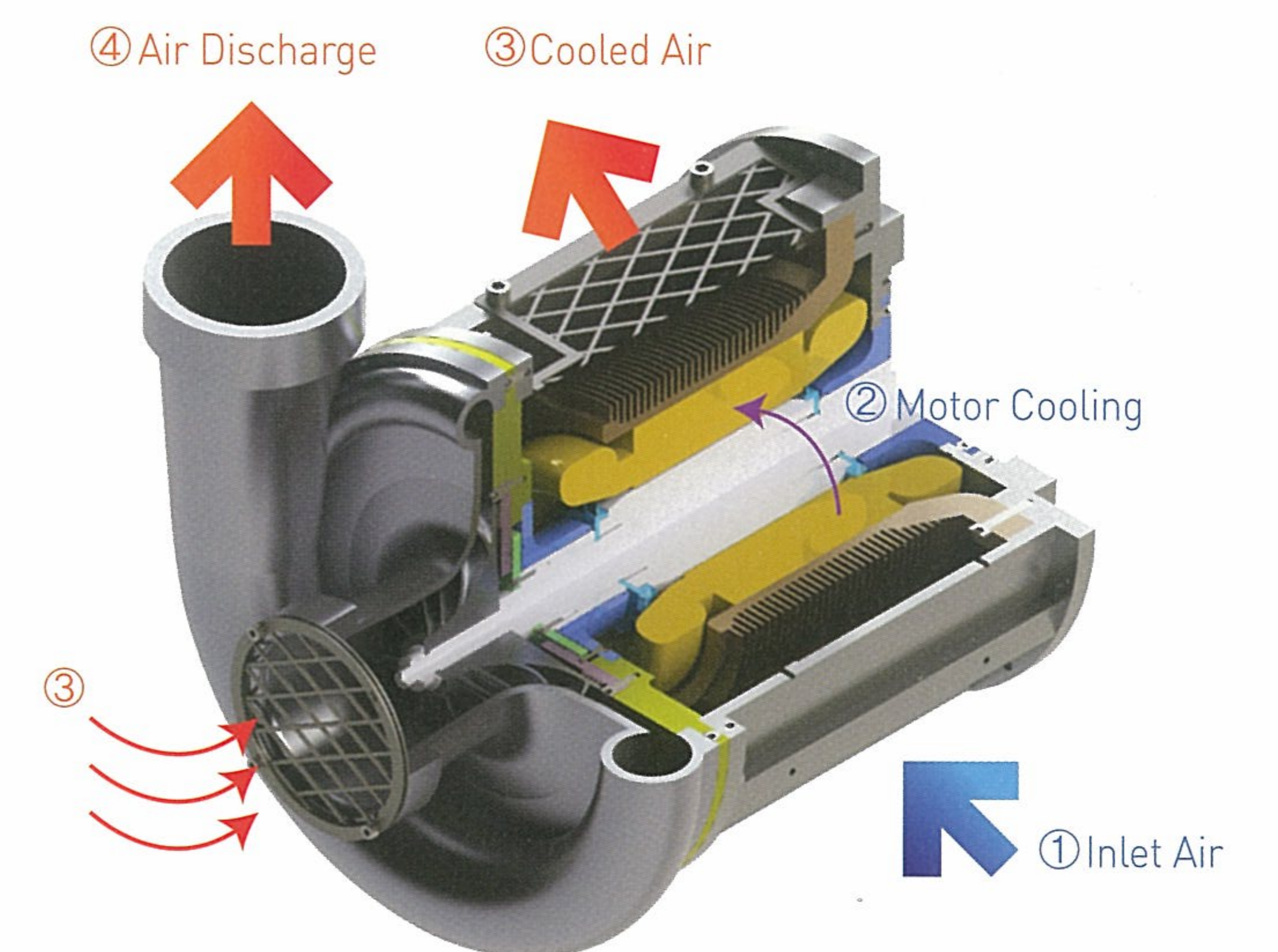

MAXIMIZE YOUR BENEFITS

- Realization of low-noise system less than 80dB(A) with enclosure enables installation in residential area
- Cost reduction by space saving and easy installation
- 100% Oil-less system provides comfortable operation



FIND OUT HOW MUCH YOU CAN SAVE

PROVIDING TOTAL MANAGEMENT SOLUTION

- Realization of optimized operation solution by flexible controls.
- Computerized intelligent group control and monitoring system provide stability for operation.

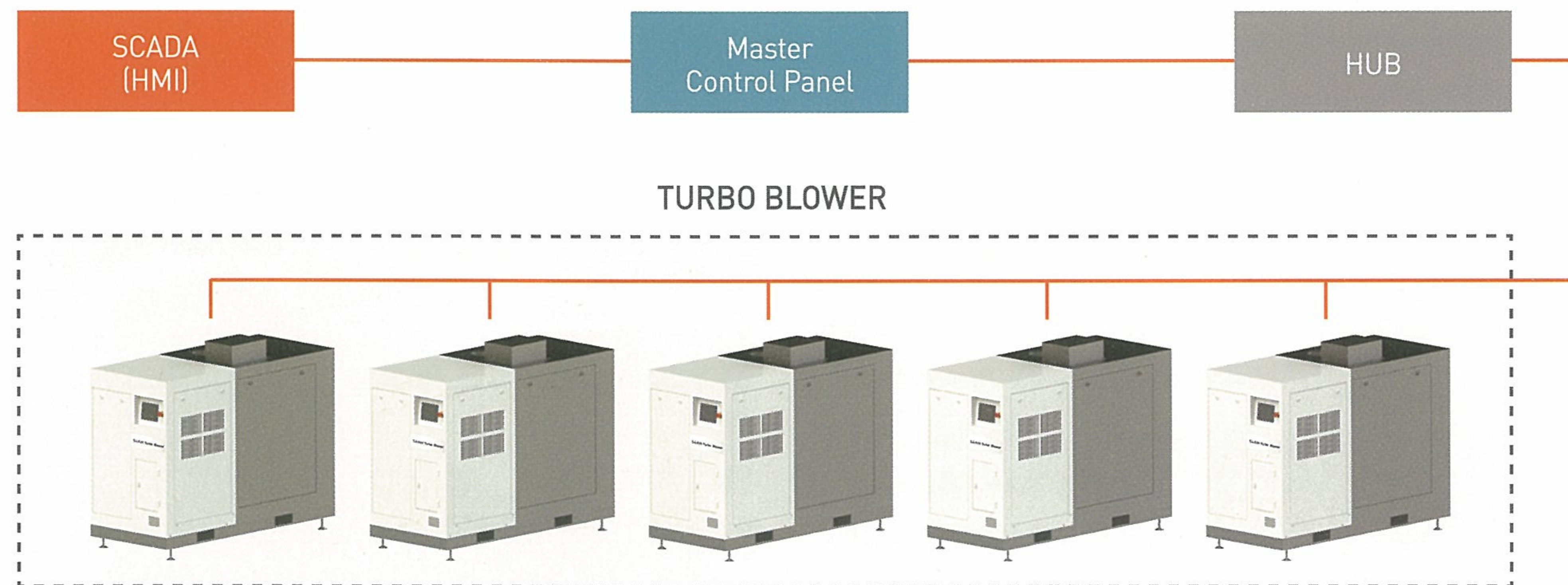

EASY MAINTENANCE WITH REASONABLE COST

- Easy replacement process of components maximizes customer's convenience.
- Simple and easy maintenance process provides high efficiency operation by reducing maintenance expenses and hours.



※ Only applicable to high capacity models

ENERGY SAVINGS OF UP TO 20~50%

A turbo blower ensures customer's profit by greatly reducing operation costs compared to conventional blowers. These excellent energy saving technologies enable investment recovery within two or three years.

- Adoption of VFD
- Adjusting motor speeds precisely according to air demand
- Maximum 20~50% savings on energy costs for operation
- Focused on energy cost reduction and maximization of customer's profits

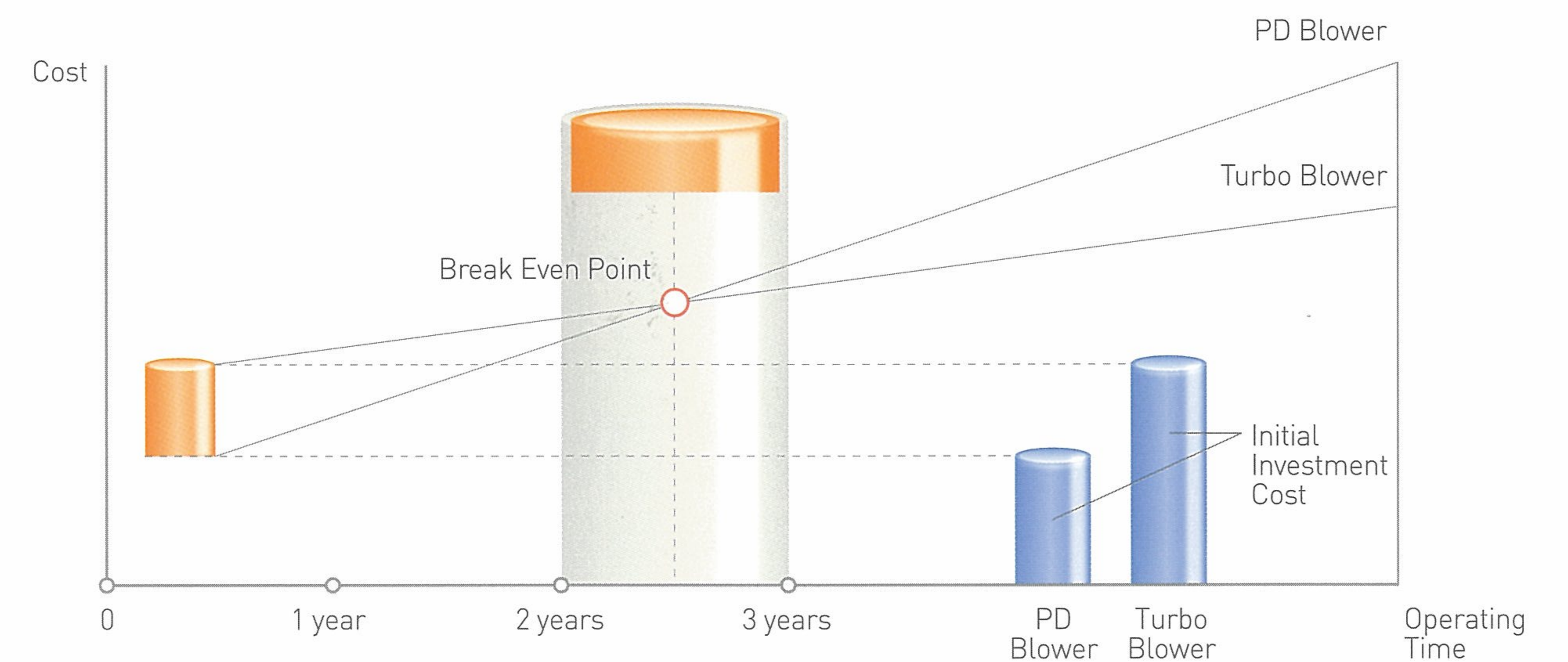
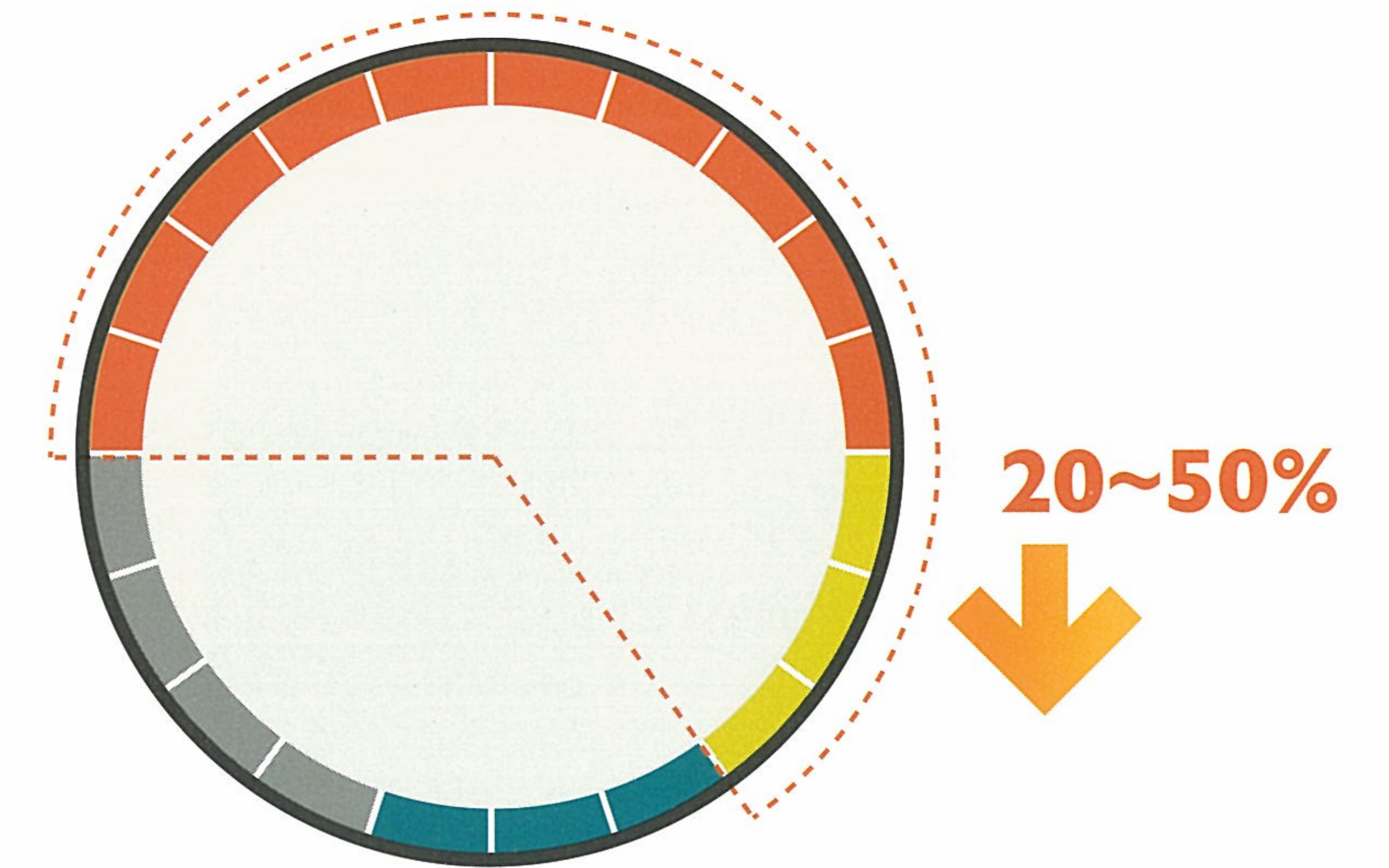

Economical effects compared to PD Blower

TECHNICAL DATA

Front View

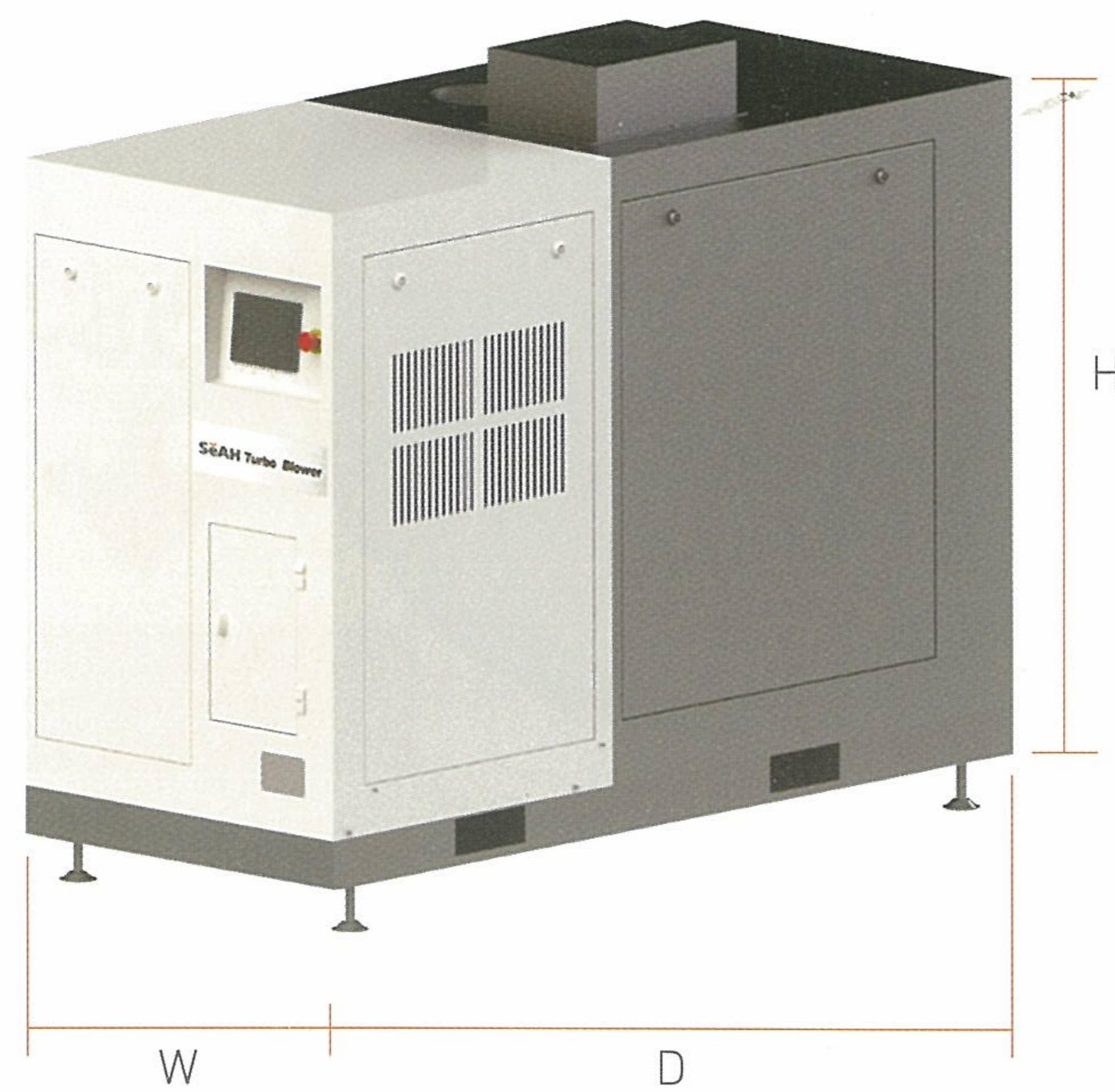

Rear View

※ Optional Types

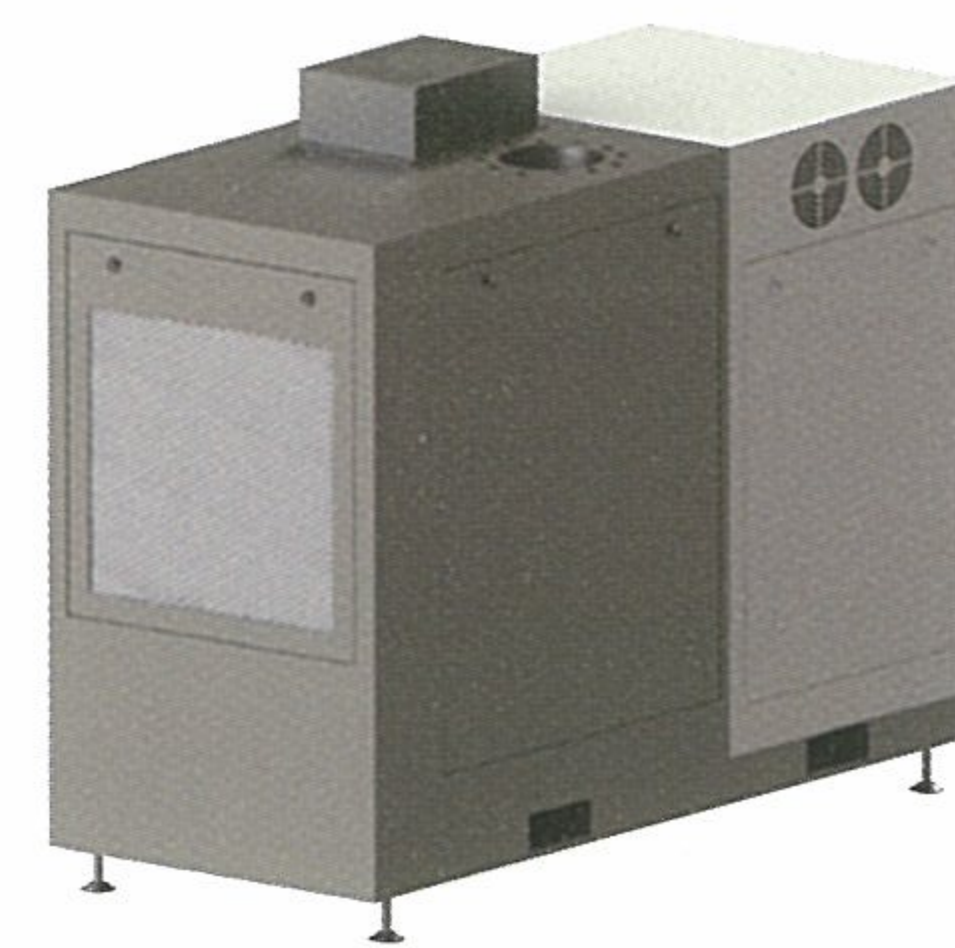

Standard Type

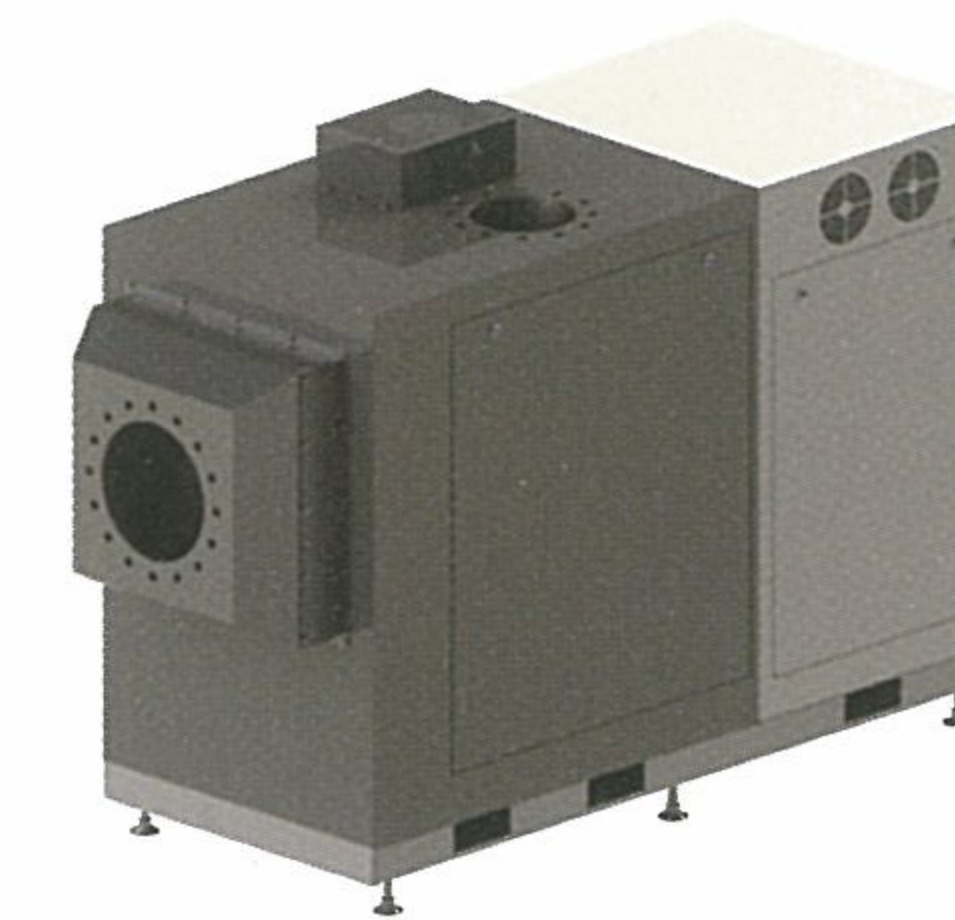

Duct(Flange) Type

MODEL SELECTION TABLE

MODEL	GT5	GT10	NGT20	NGT30	NGT50	NGT75	NGT100
Suction Flow (m ³ /min)	3.5~4.6	6.5~8.0	12.0~19.0	18.0~26.0	16.0~44.0	22.0~62.0	28.0~71.0
Dis. Pressure (kgf/cm ² G)	0.3~0.6		0.3~0.8		0.3~1.5		
Dimension	W (mm)	600	750		750	850	
	D (mm)	850		1530	1600		1950
	H (mm)	900		1150	1150		1370

MODEL	NGT125	NGT150	NGT200	NGT250	NGT300	NGT350	NGT400
Suction Flow (m ³ /min)	46.0~98.0	63.0~120.0	86.0~162.0	90.0~193.0	130.0~255.0	144.0~266.0	172.0~324.0
Dis. Pressure (kgf/cm ² G)	0.3~1.0						
Dimension	W (mm)	950	1050		1300		1500
	D (mm)	2200		2050	1900		2400
	H (mm)	1500		1700	1850		2200

※ Operation Conditions : 20°C, 1.033kgf/cm², 65%RH

※ Tolerance : ± 5%

※ As the above data may be revised and regarding special specifications, consult manufacturer.

APPLICATION

WATER AND WASTEWATER TREATMENT

- Supplies compressed air to water treatment facilities for wastewater treatment microorganism cultivation
- Increases the active oxygen with lower discharge temperature and maximizes productivity

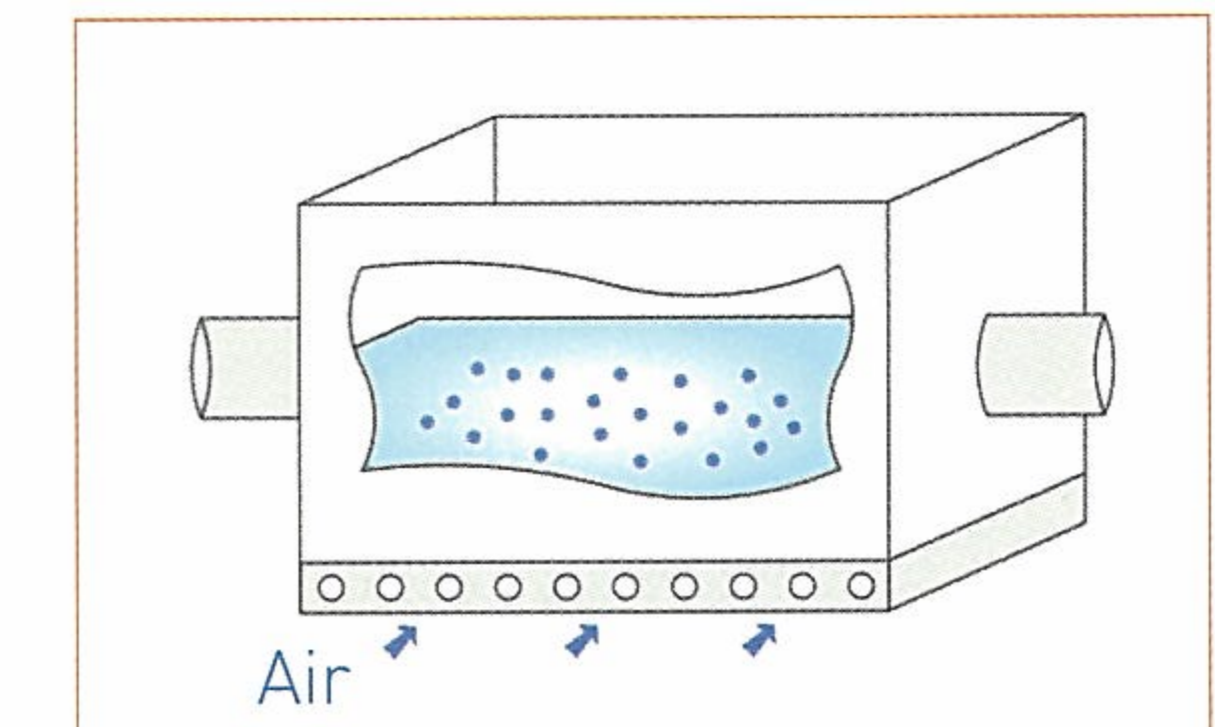

PNEUMATIC CONVEYING

- Conveys powder materials such as cement, pellet, etc. by feeding compressed air to transfer line
- Use a induction type motor in poor environment with impurities (Iron content)

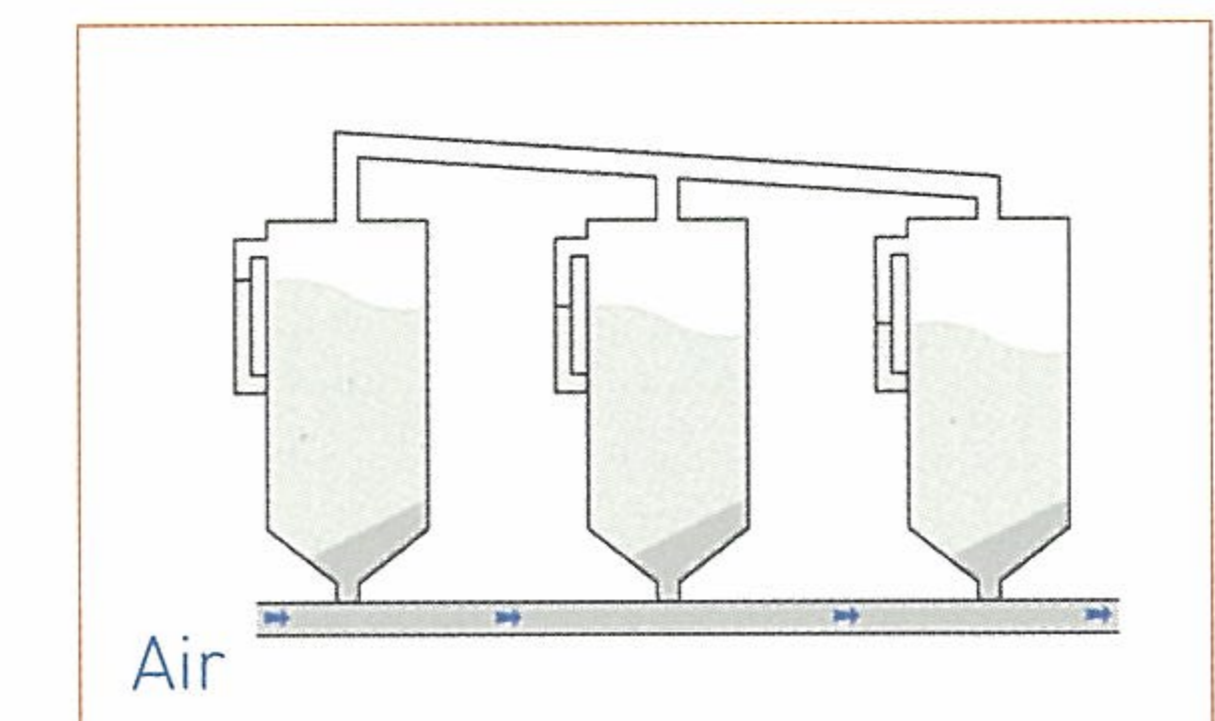

OTHERS

- Utilized for various purposes such as dry, dehumidification, burner, desulfurization, etc. in industrial sites
- Increase in productivity by drying products using compressed air without heating equipment

